

GIA COLORED DIAMOND REPORT

February 06, 2018
 Report Type Grading Report
 GIA Report Number 6183450070
 Shape and Cutting Style Cut-Cornered Rectangular
 Modified Brilliant
 Measurements 5.84 x 5.28 x 3.75 mm

Carat Weight 1.02 carat
 Color Grade Light Greenish Yellow
 Color Origin Natural
 Color Distribution Not Applicable
 Clarity Grade VS2
 Proportions:

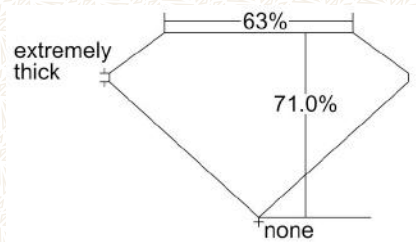

Profile not to actual proportions

Polish Good
 Symmetry Good
 Fluorescence None

Inscription(s): GIA 6183450070

Comments: Additional twinning wisps, patches of color, pinpoints and surface graining are not shown.

ADDITIONAL INFORMATION
GIA COLORED DIAMOND SCALE

Illustration of GIA fancy color grade interrelationships

GIA CLARITY SCALE

VERY VERY SLIGHTLY INCLUDED	FLAWLESS
	INTERNALLY FLAWLESS
VERY SLIGHTLY INCLUDED	VVS ₁
	VVS ₂
SLIGHTLY INCLUDED	VS ₁
	VS ₂
INCLUDED	SI ₁
	SI ₂
	I ₁
	I ₂
	I ₃

CLARITY CHARACTERISTICS

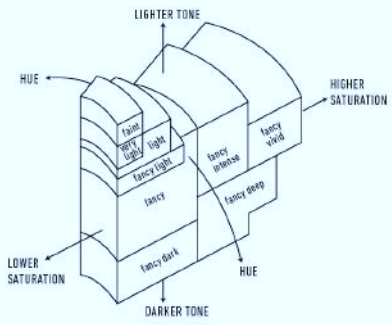
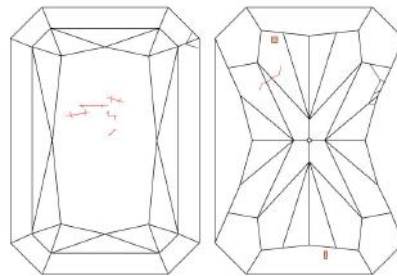
KEY TO SYMBOLS*

-  Twinning Wisp
-  Feather
-  Etch Channel
-  Extra Facet

* Red symbols denote internal characteristics (inclusions). Green or black symbols denote external characteristics (blemishes). Diagram is an approximate representation of the diamond, and symbols shown indicate type, position, and approximate size of clarity characteristics. All clarity characteristics may not be shown. Details of finish are not shown.



The results documented in this report refer only to the diamond described, and were obtained using the techniques and equipment used by GIA at the time of examination. This report is not a guarantee or valuation. For additional information and important limitations and disclaimers, please see www.gia.edu/terms or call +1 800 421 7250 or +1 760 603 4500. ©2014 Gemological Institute of America, Inc.

reportcheck.gia.edu

THE SECURITY FEATURES IN THIS DOCUMENT, INCLUDING THE HOLOGRAM, SECURITY SCREEN AND MICROPRINT LINES, IN ADDITION TO THOSE NOT LISTED, EXCEED DOCUMENT SECURITY INDUSTRY GUIDELINES.

GIA COLORED DIAMOND REPORT

March 28, 2017

Report Type Grading Report

GIA Report Number 2181227943

Shape and Cutting Style Cut-Cornered Rectangular
Modified Brilliant

Measurements 5.93 x 5.36 x 3.65 mm

Carat Weight 1.07 carat

Color Grade Fancy Light Yellow-Green

Color Origin Natural

Color Distribution Even

Clarity Grade SI1

Proportions:

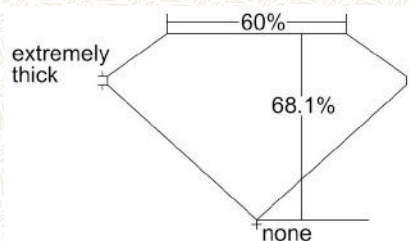

Profile not to actual proportions

Polish Excellent

Symmetry Very Good

Fluorescence None

Inscription(s): GIA 2181227943

Comments: Additional twinning wisps, pinpoints, a patch of color and surface graining are not shown.

ADDITIONAL INFORMATION

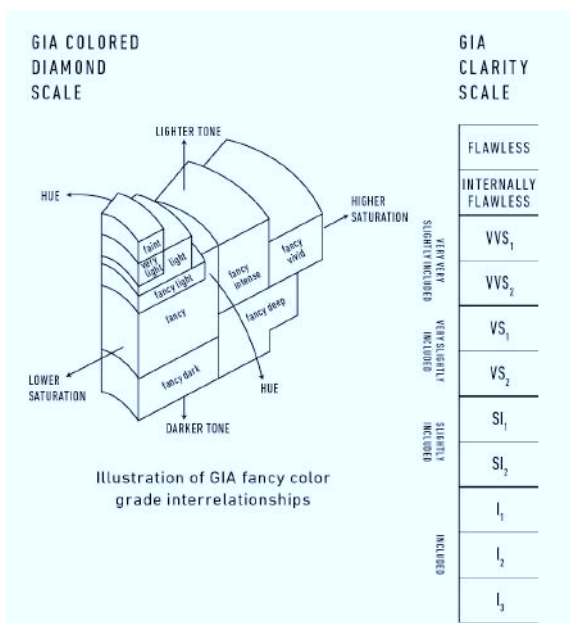

CLARITY CHARACTERISTICS

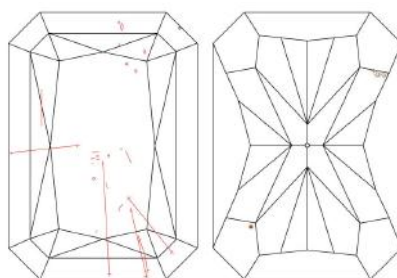

KEY TO SYMBOLS*

- Twinning Wisp
- Crystal
- Feather
- Needle
- Indented Natural
- Etch Channel
- Extra Facet

* Red symbols denote internal characteristics (inclusions). Green or black symbols denote external characteristics (blemishes). Diagram is an approximate representation of the diamond, and symbols shown indicate type, position, and approximate size of clarity characteristics. All clarity characteristics may not be shown. Details of finish are not shown.



reportcheck.gia.edu



The results documented in this report refer only to the diamond described, and were obtained using the techniques and equipment used by GIA at the time of examination. This report is not a guarantee or valuation. For additional information and important limitations and disclaimers, please see www.gia.edu/terms or call +1 800 421 7250 or +1 760 603 4500. ©2014 Gemological Institute of America, Inc.



THE SECURITY FEATURES IN THIS DOCUMENT, INCLUDING THE HOLOGRAM, SECURITY SCREEN AND MICROPRINT LINES, IN ADDITION TO THOSE NOT LISTED, EXCEED DOCUMENT SECURITY INDUSTRY GUIDELINES.

GIA COLORED DIAMOND REPORT

September 19, 2017

Report Type Grading Report

GIA Report Number 2181724202

Shape and Cutting Style Cushion Modified Brilliant

Measurements 3.42 x 3.26 x 2.43 mm

Carat Weight 0.25 carat

Color Grade Fancy Light Orangy Pink

Color Origin Natural

Color Distribution Even

Clarity Grade VS2

Proportions:

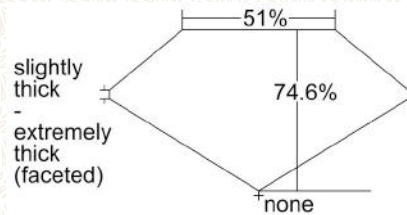

Profile not to actual proportions

Polish Good

Symmetry Fair

Fluorescence Strong Blue

Inscription(s): GIA 2181724202

ADDITIONAL INFORMATION

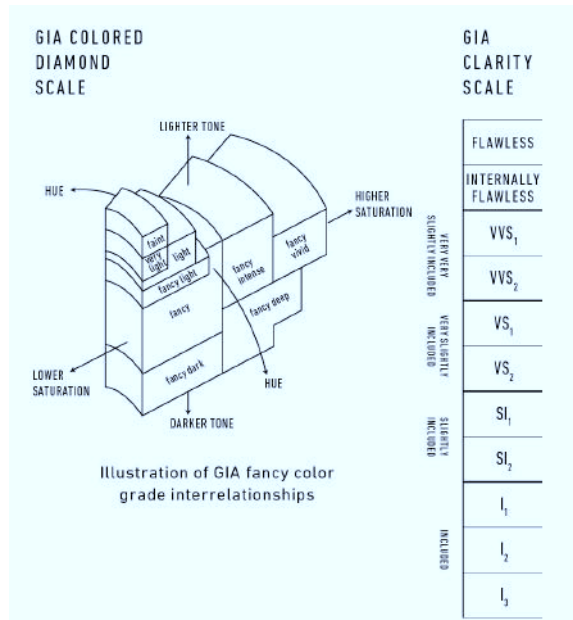

CLARITY CHARACTERISTICS

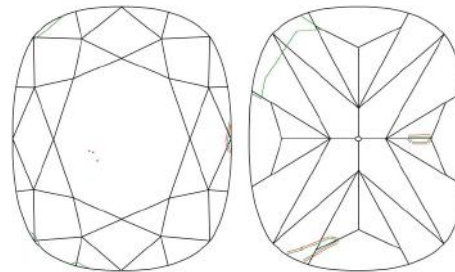

KEY TO SYMBOLS*

-  Indented Natural
-  Pinpoint
-  Natural

* Red symbols denote internal characteristics (inclusions). Green or black symbols denote external characteristics (blemishes). Diagram is an approximate representation of the diamond, and symbols shown indicate type, position, and approximate size of clarity characteristics. All clarity characteristics may not be shown. Details of finish are not shown.



reportcheck.gia.edu



The results documented in this report refer only to the diamond described, and were obtained using the techniques and equipment used by GIA at the time of examination. This report is not a guarantee or valuation. For additional information and important limitations and disclaimers, please see www.gia.edu/terms or call +1 800 421 7250 or +1 760 603 4500. ©2014 Gemological Institute of America, Inc.

 THE SECURITY FEATURES IN THIS DOCUMENT, INCLUDING THE HOLOGRAM, SECURITY SCREEN AND MICROPRINT LINES, IN ADDITION TO THOSE NOT LISTED, EXCEED DOCUMENT SECURITY INDUSTRY GUIDELINES.

GIA COLORED DIAMOND REPORT

November 03, 2017
 Report Type Grading Report
 GIA Report Number 2185844466
 Shape and Cutting Style Cushion Modified Brilliant
 Measurements 3.24 x 3.21 x 2.54 mm

Carat Weight 0.25 carat
 Color Grade Fancy Orangy Pink
 Color Origin Natural
 Color Distribution Even
 Clarity Grade I1
 Proportions:

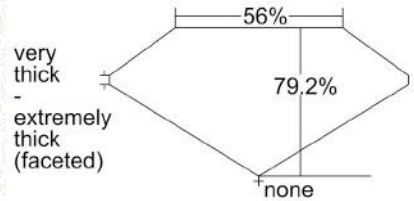

Profile not to actual proportions

Polish Good
 Symmetry Good
 Fluorescence None
 Inscription(s): GIA 2185844466

ADDITIONAL INFORMATION

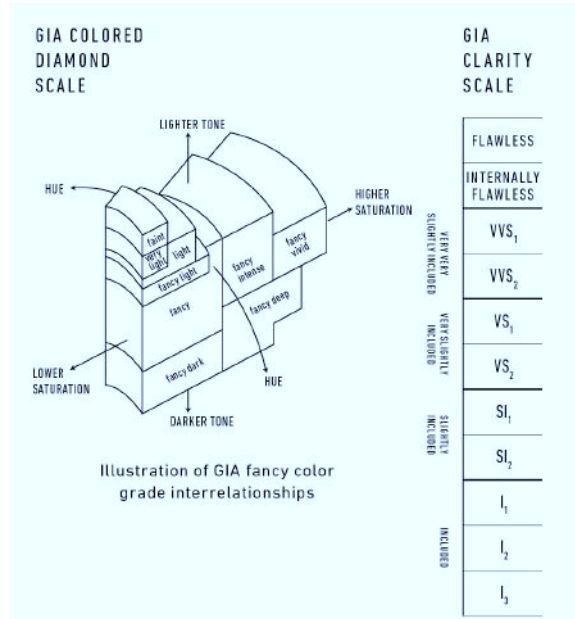

CLARITY CHARACTERISTICS

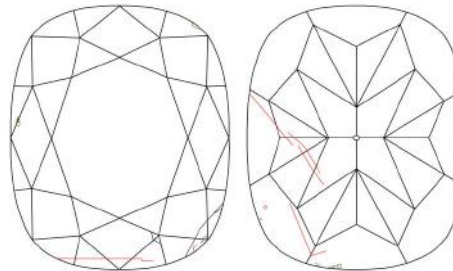

KEY TO SYMBOLS*

- Feather
- Crystal
- Cavity
- Indented Natural
- Natural
- Extra Facet

* Red symbols denote internal characteristics (inclusions). Green or black symbols denote external characteristics (blemishes). Diagram is an approximate representation of the diamond, and symbols shown indicate type, position, and approximate size of clarity characteristics. All clarity characteristics may not be shown. Details of finish are not shown.



reportcheck.gia.edu



The results documented in this report refer only to the diamond described, and were obtained using the techniques and equipment used by GIA at the time of examination. This report is not a guarantee or valuation. For additional information and important limitations and disclaimers, please see www.gia.edu/terms or call +1 800 421 7250 or +1 760 603 4500. ©2014 Gemological Institute of America, Inc.

THE SECURITY FEATURES IN THIS DOCUMENT, INCLUDING THE HOLOGRAM, SECURITY SCREEN AND MICROPRINT LINES, IN ADDITION TO THOSE NOT LISTED, EXCEED DOCUMENT SECURITY INDUSTRY GUIDELINES.